

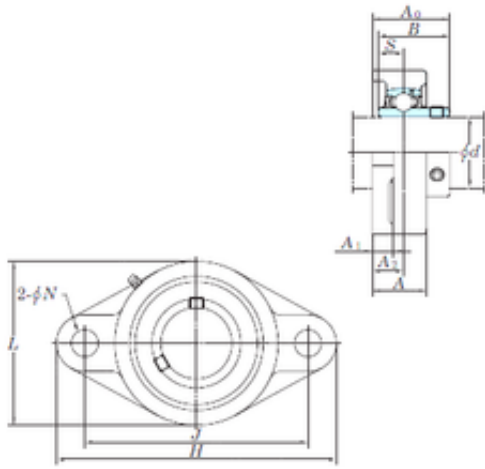

Huaxin Bearing Co., Ltd

KOYO UCFL206-18 bearing units

Bearing No. UCFL206-18



UCFL206-18 Bearing 2D drawings and 3D CAD models

Bore Diameter	28,575 mm
d	28,575 mm
A0	40,2 mm
A	31 mm
A1	13 mm
B	38,1 mm
H	148 mm
J	117 mm
L	80 mm
N	16 mm
S	15,9 mm
A2	18 mm
Weight	0,93 Kg
Basic static load rating (C0)	19,5 kN